

OXUS ehf

Umboðs- og heildverslun

Vörulisti 2026

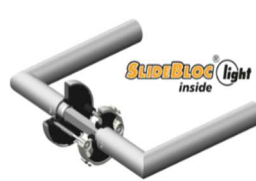
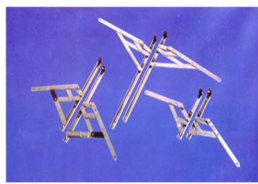
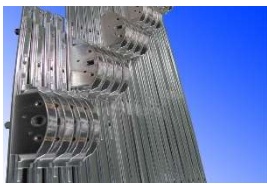

Akralind 6
201 Kópavogi
Sími 5 444 888
Fax 5 444 889
Netfang: oxus@oxus.is
www.oxus.is

Mest seldu gluggalamirnar á Íslandi í 20 ár



Ryðfríar brautalamir fyrir opnanleg fög

Avocet brautalamirnar eru allar úr SS304 ryðfríu stáli og hafa staðist kröfur samkvæmt : MOAT No. 1: 1974 UEAtc "Directive for the Assessments for Windows". Rannsóknarstofnun Byggingariðnaðarins hefur farið yfir þær prófanir og hefur samþykkt notkun þeirra við íslenskar aðstæður (prófun Nr.H02/79) í samræmi við leiðbeiningar framleiðanda. Avocet brautalamirnar eru til fyrir topphengd og hliðarhengd fög. Þær eru fyrir mjög algengt úrtak, 16 x 5.5 mm úrtak í karmi og 16 x 2.5 mm í falsi. Bil milli karms og fals þarf að vera 6 mm. Topphengdu brautalamirnar eru með barnaöryggi í 12", 16", 20" og 24" stærðum.

Hliðarhengdu brautalamirnar henta mjög vel fyrir neyðarútganga þar sem þær koma í svokallaðri "EGRESS" útgáfu og opnast beint í 90°. Einnig er hægt að nota hliðarhengdar lamir í topphengd fög ef óskað er eftir að fag lækki ekki niður við opnun.

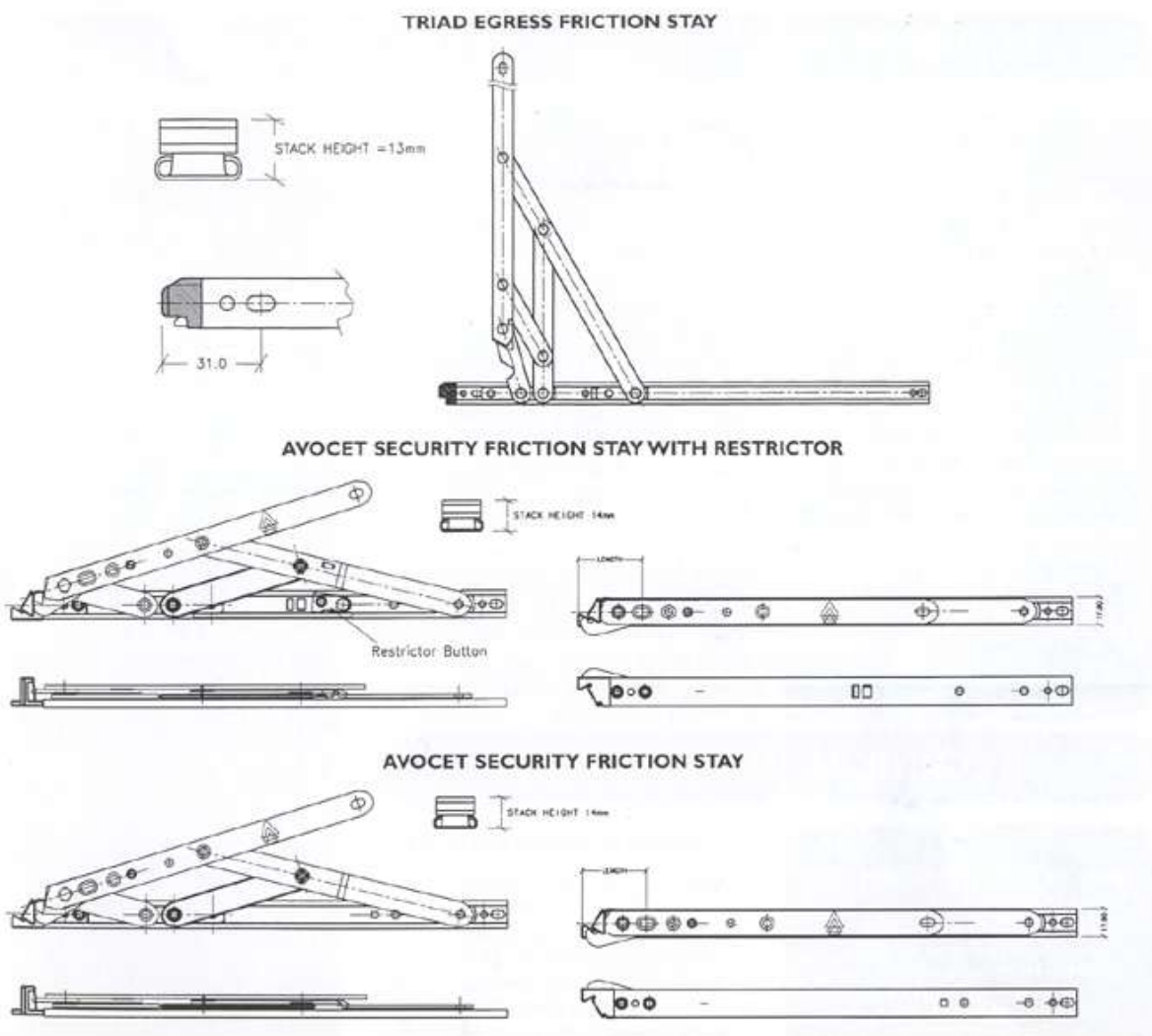

Vörunnr.	Vöruheiti	Lengd	Breidd botns og arms	Hámarks kg.	Hámarks hæð faga	Pakkning
41608	Avocet brautalöm topphengd RF	8" /20 cm	15,5 mm	12 kg	35 cm	5 x 10 pör í ks
41610	Avocet brautalöm topphengd RF	10" /25 cm	15,5 mm	14 kg	40 cm	6 x 10 pör í ks
416121	Avocet brautalöm topphengd RF BÖ	12" /30 cm	15,5 mm	16 kg	55 cm	4 x 10 pör í ks
416162	Avocet brautalöm hliðhengd RF (breidd)	16" /40 cm	15,5 mm	24 kg	120 x 65 cm	4 x 10 pör í ks
416161	Avocet brautalöm topphengd RF BÖ	16" /40 cm	15,5 mm	20 kg	80 cm	3 x 10 pör í ks
416201	Avocet brautalöm topphengd RF BÖ	20" /50 cm	15,5 mm	24 kg	90 cm	3 x 10 pör í ks
416241	Avocet brautalöm topphengd RF HD BÖ	24" /60 cm	15,5 mm	35 kg	120 cm	2 x 10 pör í ks

BÖ = Barna öryggi
 RF = Ryðfrítt
 HD = Heavy Duty (sérstyrktar)

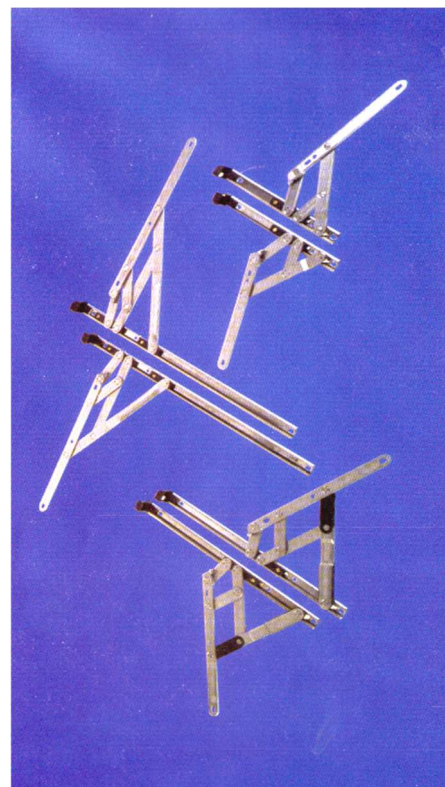
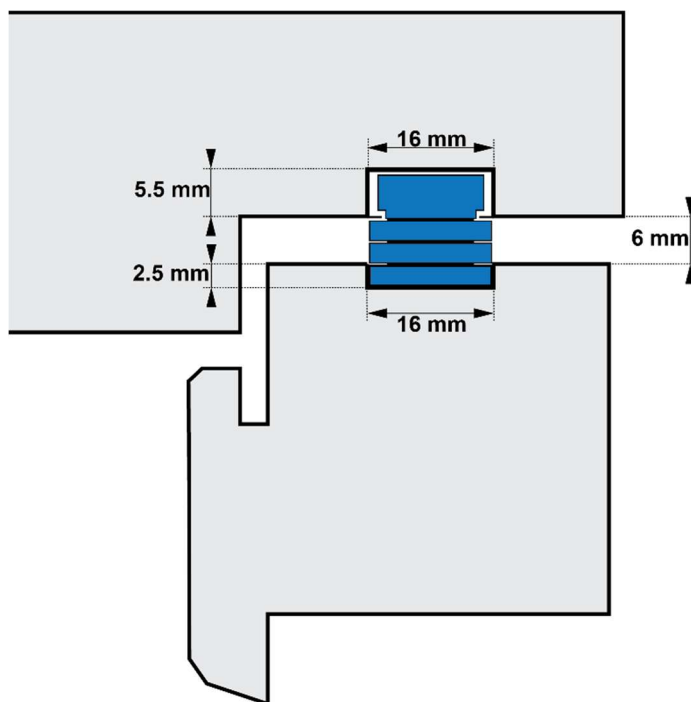



Brautalamir

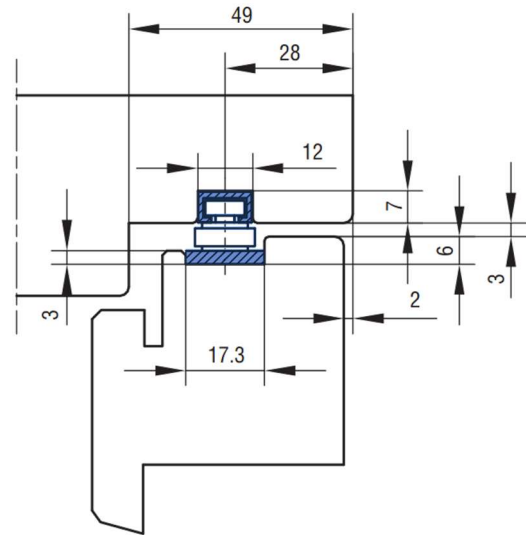
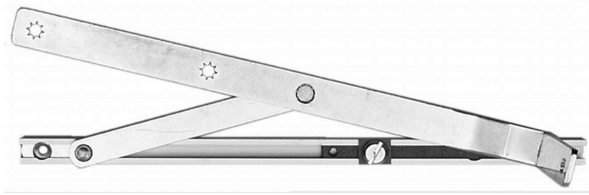

Vörunr.	Vöruheiti	Lengd	Breidd botns og arms	Hámarks kg.	Hámarks hæð fags	Pakkning
419175	IPA Brautalamir 12x7	160 mm	12 og 17 mm	20 kg	30 cm	5
419170	IPA Brautalamir 12x7	263 mm	12 og 17 mm	40 kg	84 cm	25
419173	IPA Brautalamir 12x7	453 mm	12 og 17 mm	50 kg	134 cm	25
419174	IPA Brautalamir 12x7	711 mm	12 og 17 mm	70 kg	154 cm	5

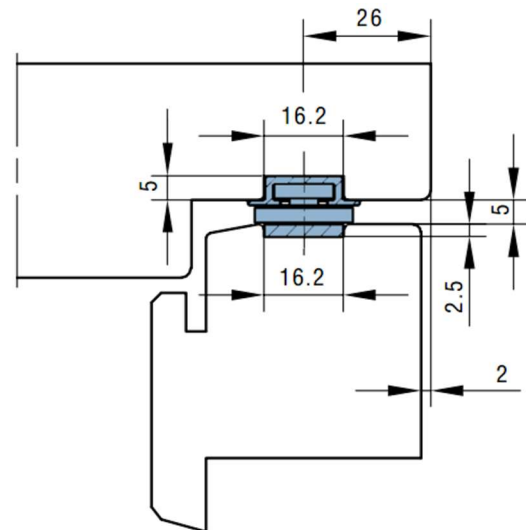

Vörunr.	Vöruheiti	Lengd	Breidd botns og arms	Hámarks kg.	Hámarks hæð fags	Pakkning
418575	IPA Brautalamir 16x5	160 mm	16 mm	20 kg	30 cm	5
418570	IPA Brautalamir 16x5	263 mm	16 mm	40kg	84 cm	25
418573	IPA Brautalamir 16x5	453 mm	16 mm	50 kg	134 cm	25
418574	IPA Brautalamir 16x5	711 mm	16 mm	70 kg	154 cm	5



Býskar skrár fyrir innihurðir

BKS skrárnar koma með ryðfrírri framhlið og slúttjárnnum. 3 gerðir. Fyrir Euro-síldra, lykla og baðsnerla. Skrá fyrir það er fyrir 8 mm pinna.



660415H/V



660215H/V



660216H/V

Vörunr.	Vöruheiti	Lengd framhliðar	Breidd framhliðar	Litur	Dýpt gats / heildardýpt	Leng milli gata
660215H	BKS skrá fyrir lykla hægri	235 mm	24 mm	RF	55/80 mm	72 mm
660215V	BKS skrá fyrir lykla vinstri	235 mm	24 mm	RF	55/80 mm	72 mm
660216H	BKS skrá fyrir baðsn. hægri	235 mm	24 mm	RF	55/80 mm	72 mm
660216V	BKS skrá fyrir baðsn. vinstri	235 mm	24 mm	RF	55/80 mm	72 mm
660415H	BKS skrá fyrir Euro síl. hægri	235 mm	24 mm	RF	55/80 mm	72 mm
660415V	BKS skrá fyrir Euro síl. vinstri	235 mm	24 mm	RF	55/80 mm	72 mm
663535SL	Euro sílinder 35x35 mm SL			Króm		
664040SL	Euro sílinder 40x40 mm SL			Satin		
663555SL	Euro sílinder 35x55 mm SL			Satin		
664545SL	Euro sílinder 45x45 mm SL			Satin		
665535SL	Euro sílinder 55x35 mm SL			Satin		

Eigum til töluvert úrval af RF húnum og rósettum fyrir BKS skrárnar.



Euro sílindrar





Sjálfvirkar og venjulegar þriggja punkta útihurðalæsingar

Automatic

Einnig fánleg með rafmagnsmótor. Fyrir fjarstýrða opnun dyrasíma eða fjarstýringu.

Lásbolti	35 mm x 20 mm
Efni	Stál
Litur/húð	Krómað
Lástegund	Euro sílinder
Láshús	70 mm x 195 mm
Láshús uppi / niðri	
Lásmiðja (handf.)	55 mm
Lásmiðja í læsingu	92 mm
Lengd	2285 mm

Basic

Uppi / Niðr	16 mm shootbolt
Lásbolti	35 mm x 20 mm
Efni	Stál
Litur/húð	Krómað
Lástegund	Euro sílinder
Láshús	70 mm x 195 mm
Lásmiðja (handf.)	55 mm
Lásmiðja í læsingu	92 mm
Lengd	1375mm + 742/973mm
mm	



Slúttjárn stillanleg 622851-52

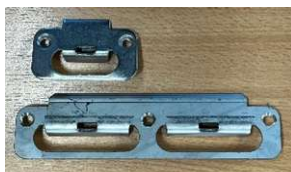

Slúttjárn RF 62282-84

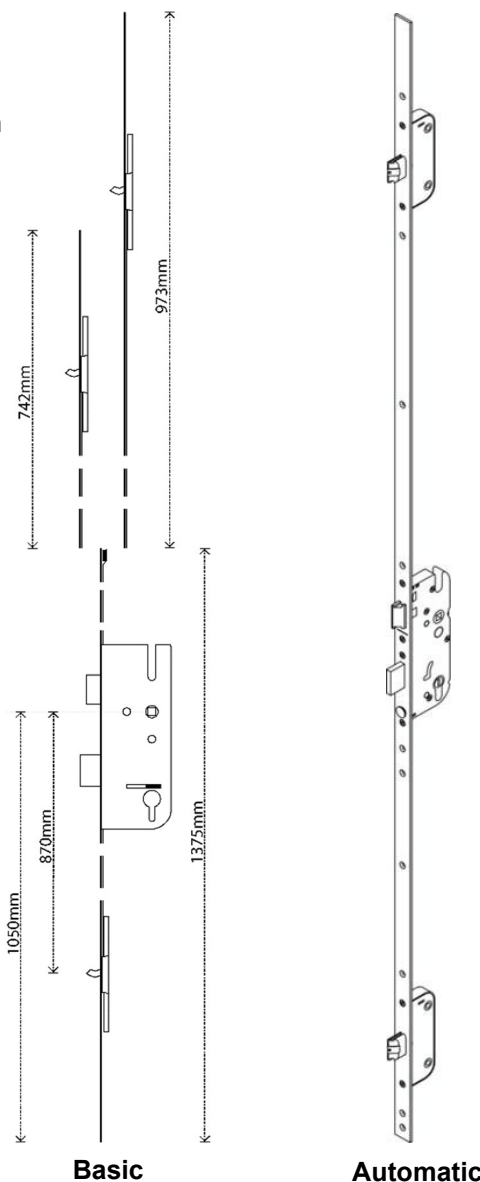

Basic

Automatic

Vörunr.	Vöruheiti	Lengd	Dýpt gats	Litur	Láshús mm	Pakkning
62290-1-2	G-U Útihurðalæsing Basic	1375 mm	35-50-55 mm	Króm	70x195 mm	5 stk
62294	G-U Framlenging f/ Basic	742 mm		Króm		5 stk
62296	G-U Framlenging f/ Basic	973 mm		Króm		5 stk
62216	G-U Útihurðalæsing Autom.	2285 mm	55 mm	Króm	70x195 mm	5 stk
62226	G-U Framlenging f/ Autom.	500 mm		Króm		5 stk
62282-4	Slúttjárn RF. Miðja / Endar	65/167 mm		RF		
622851-2	Slúttjárn Stillanl. M / E	125/195mm		Króm		



GU Raflæsingabúnaður fyrir útihurðir / Intensa Rafhúnar

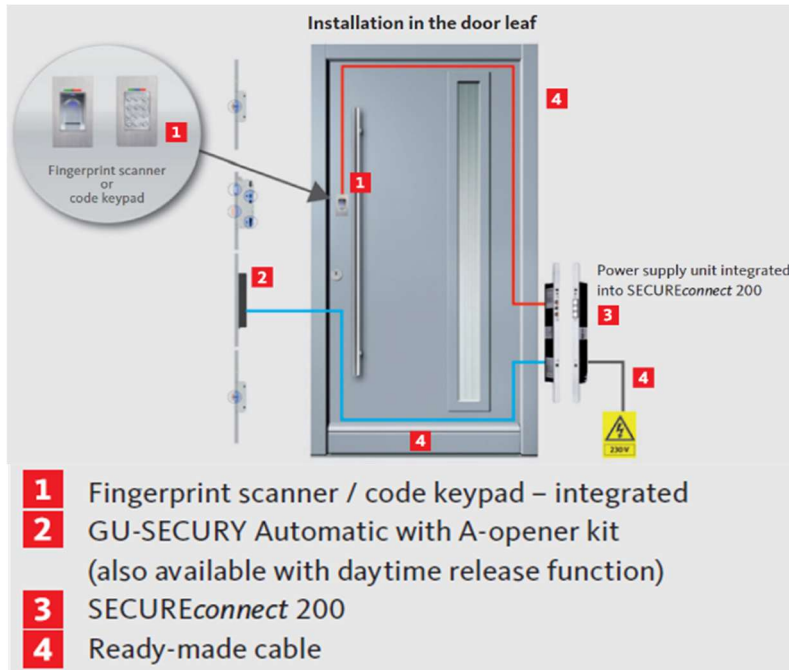

GU Raflæsingar í hurð



A-Opener mótör sett



SECUREconnect 200

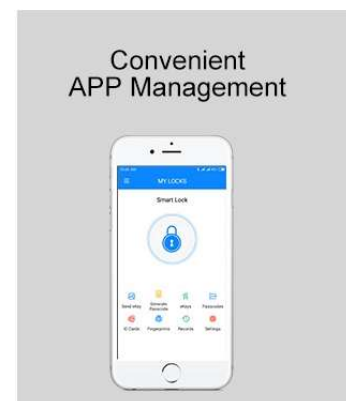
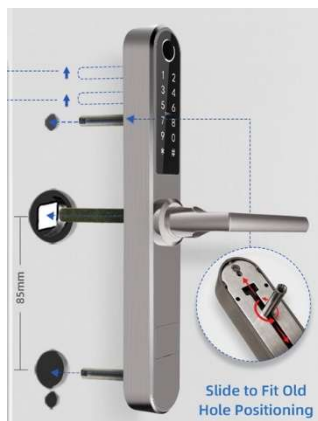

Vörunr.	Vöruheiti	Pakkning
623002	G-U A-Opener Mótör sett fyrir raf-útihurðalæsingu Automatic	1
623004	G-U SECUREconnect 200 fyrir Raflæsingar	1
623012	G-U Raflæsinga sett með Keypad, Mótör, Connector	1
623150	G-U Hlífar fyrir SECUREconnect í hurð og karm	1
622866	Intensa Rafhúnn. Talnalás, ID kort, Bluetooth og Lykill / Silfur.	1
622868	Intensa Rafhúnn. Talnalás, ID kort, Bluetooth og Lykill / Svartur	1



Gluggalæsingar með stýripinna og mótstykki, úr ryðfríu stáli, með næturopnun

Stólpi / Plata	16/17 mm
Efni	Járn
Yfirborð	Krómað
Sveppir	Ryðfrír
Fjöldi sveppa	2 stk. (300-1200mm)
Stýritappi	1 stk. í miðju. Ø 11 mm
Húnagat	8 mm
Húnagatsdýpt	28 mm (Backset)
Láshússdýpt	Húngatsdýpt + 9 mm
Lengd	(L) í töflu
Lengd m/sveppa	(C) í töflu

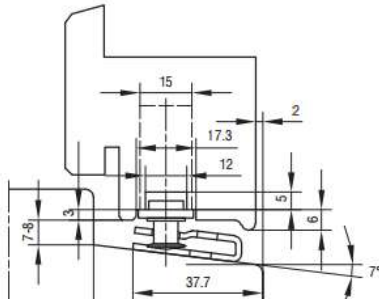

RF mótstk. fyrir gluggalæs
Vörunnr: 61900

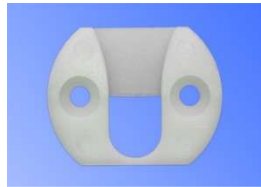

Klossi fyrir stýripinna
Vörunnr: 61901

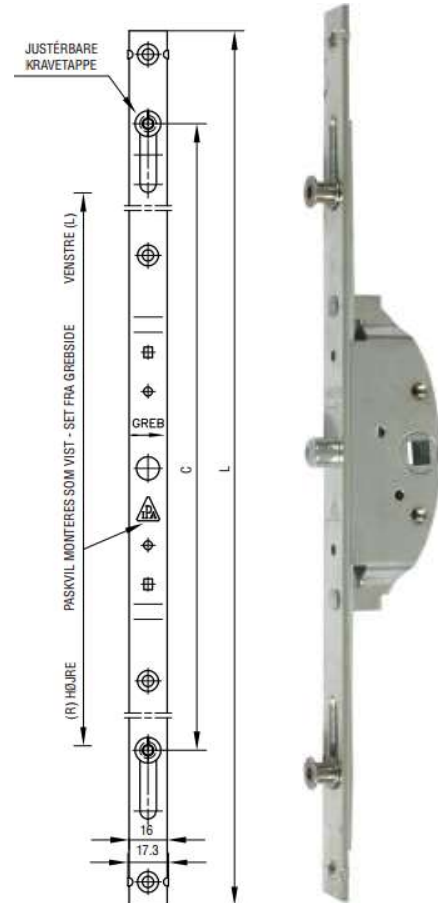

Vörunnr.	Vöruheiti	Lengd (L)	Milli kólva (C)	Dýpt / Húnagat	Litur	Pakkning
60300	IPA Gluggalæsing m/stýringu 16	300 mm (2)	190 mm	28 / 8 mm	Krómm	10
60400	IPA Gluggalæsing m/stýringu 16	400 mm (2)	295 mm	28 / 8 mm	Krómm	10
60500	IPA Gluggalæsing m/stýringu 16	500 mm (2)	395 mm	28 / 8 mm	Krómm	10
60600	IPA Gluggalæsing m/stýringu 16	600 mm (2)	495 mm	28 / 8 mm	Krómm	10
60700	IPA Gluggalæsing m/stýringu 16	700 mm (2)	595 mm	28 / 8 mm	Krómm	10
60800	IPA Gluggalæsing m/stýringu 16	800 mm (2)	695 mm	28 / 8 mm	Krómm	10
60900	IPA Gluggalæsing m/stýringu 16	900 mm (2)	795 mm	28 / 8 mm	Krómm	10
61000	IPA Gluggalæsing m/stýringu 16	1000 mm (2)	895 mm	28 / 8 mm	Krómm	10
61100	IPA Gluggalæsing m/stýringu 16	1100 mm (2)	995 mm	28 / 8 mm	Krómm	10
61200	IPA Gluggalæsing m/stýringu 16	1200 mm (2)	1095 mm	28 / 8 mm	Krómm	10



Stangarlæsingar fyrir svalahurðir og hliðhengd fög

Stólpi	16/17 mm
Efni	Járn
Yfirborð	Krómað
Kólvar	17 mm
Fjöldi Kólva	2 stk. (440-1420mm)
Fjöldi Kólva	3 stk. Svalahurðaskrá
Húnagat	8 mm
Húnagatsdýpt	28 mm/Svalas.40 mm
Láshússdýpt	37 mm/Svalas.49 mm
Lengd	Í töflu
Lengd m/ kólva	Í töflu

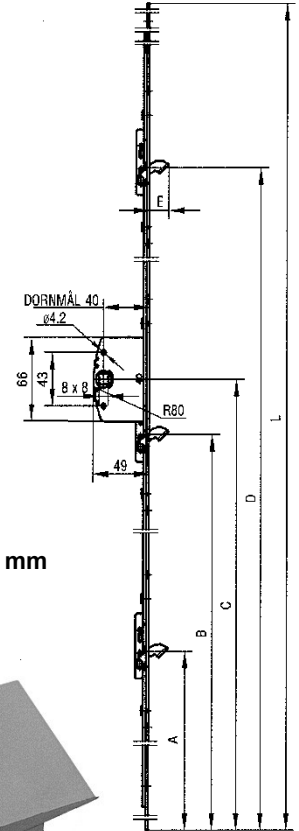
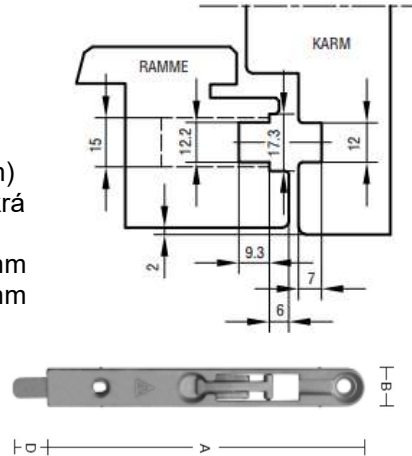

Kantrílar B = 17 mm / A = 128 mm / D = Ríll 20 mm
Vörunr. 63333



Ryðfrítt Mótstykki f/ stangarlæsingar
Vörunr: 62903

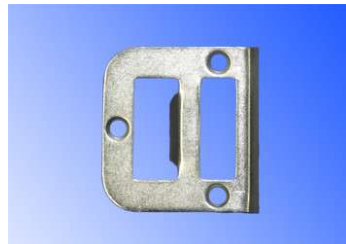

Mótstykki f/ stangarlæsingar
Vörunr: 62900

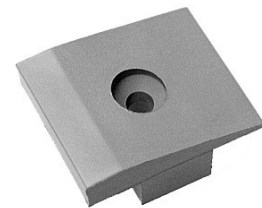

Stýriklossi fyrir opnanleg fög
Vörunr.61910

!3551-53

Vörunr.	Vöruheiti / Stólpi mm	Lengd (kólvar)	Milli kólva	Litur	Dýpt/Húnagat	Pakkning
63044	IPA Gluggalæsing f/ hliðh./16	440 mm (2)	100 mm	Króm	28 / 8 mm	10
63060	IPA Gluggalæsing f/ hliðh./16	600 mm (2)	280 mm	Króm	28 / 8 mm	10
63072	IPA Gluggalæsing f/ hliðh./16	720 mm (2)	280 mm	Króm	28 / 8 mm	10
63082	IPA Gluggalæsing f/ hliðh./16	820 mm (2)	380 mm	Króm	28 / 8 mm	10
63092	IPA Gluggalæsing f/ hliðh./16	920 mm (2)	480 mm	Króm	28 / 8 mm	10
63102	IPA Gluggalæsing f/ hliðh./16	1020 mm (2)	580 mm	Króm	28 / 8 mm	10
63112	IPA Gluggalæsing f/ hliðh./16	1120 mm (2)	680 mm	Króm	28 / 8 mm	10
63122	IPA Gluggalæsing f/ hliðh./16	1220 mm (2)	780 mm	Króm	28 / 8 mm	10
63132	IPA Gluggalæsing f/ hliðh./16	1320 mm (2)	880 mm	Króm	28 / 8 mm	10
63142	IPA Gluggalæsing f/ hliðh./16	1420 mm (2)	970 mm	Króm	28 / 8 mm	10
62110	IPA Svalahurðaskrá /16/17	2110 mm (3)	740<m>740 mm	Króm	40 / 8 mm	10



Bremgur fyrir hliðhengdar læsingar



63212-4



Bremsa 418580

Vörunr.	Vöruheiti	Lengd (kólvar)	Fræsing	Litur	Pakkning
63200	IPA Bremsa f/hliðh.glugga	330-480 mm	12x10/16x3 mm	silfur	10
63202	IPA Bremsa f/hliðh.glugga	481-690 mm	12x10/16x3 mm	silfur	10
63204	IPA Bremsa f/hliðh.glugga+hurðir	691-900 mm	12x10/16x3 mm	silfur	10
63206	IPA Bremsa f/hliðh.glugga+hurðir	901-1100 mm	12x10/16x3 mm	silfur	10
63208	IPA Mótstykki f/ bremsu. IPA nótt	12x9 mm	12x9 mm	grátt	10
63210	IPA Mótstykki f/ bremsu. PN nótt	16x5 mm	16x5 mm	grátt	10
63212	IPA Tengikúpling f/ bremsu	63 mm		galv.	10
63214	IPA Tengikúpling f/ bremsu	100 mm		galv.	10
418580	IPA Bremsa 16x5 f/ HH glugga	274 mm	16x5 mm	silfur	25



Handföng satin silfur flöt f/ IPA – læsingar
61975-6 (43mm)



Handföng með tungu og næturopnun
40101-02-03-04

Vörunr.	Vöruheiti	Lengd	H eða V	Litur	Stærð pinna	Pakkning
61975-6	Handföng f/ læsingar satin silfur flöt	12,5 cm	Hægri/Vinstri	Silfur	8 mm	10
40101	Handföng m/ tungu og næturopnun	12 cm	Hægri	Hvítur	Utánaliggj.	40
40102	Handföng m/ tungu og næturopnun	12 cm	Vinstri	Hvítur	Utánaliggj.	40
40103	Handföng m/ tungu og næturopnun	12 cm	Hægri	Silfur	Utánaliggj.	40
40104	Handföng m/ tungu og næturopnun	12 cm	Vinstri	Silfur	Utánaliggj.	40

Bréfalúgur

Bréfalúgur Plus Line

lúgurnar koma í fimm litum og eru í hæsta gæðaflokki, með þéttlista og bursta á mjög sanngjörnu verði.

Vörunúmer	Vöruheiti	Litur	Stærð	Úrtak	Pakkning
50030	Plus Line	Svört	B:30,8 cm x H:6,8 cm	B:28,5 cm x H: 4,8 cm	15 í kassa
50032	Plus Line	Hvít	B:30,8 cm x H:6,8 cm	B:28,5 cm x H: 4,8 cm	15 í kassa
50033	Plus Line	Gull	B:30,8 cm x H:6,8 cm	B:28,5 cm x H: 4,8 cm	15 í kassa
50035	Plus Line	Silfur	B:30,8 cm x H:7,6 cm	B:28,5 cm x H: 4,8 cm	15 í kassa
50038	Plus Line	Graphite	B:30,8 cm x H:6,8 cm	B:28,5 cm x H: 4,8 cm	15 í kassa



Plus Line 50030-32-33-35-38



KDH Innihurðalamir / Eldvarnarlamir

KDH hurðalamirnar eru til í mörgum útfærslum. Þær eru framleiddar eftir ströngustu gæðakröfum og útfærðar sérstaklega fyrir hurðaframleiðendur á Íslandi.

KDH ryðfríu samstungnu 89x89 mm lamirnar (mynd til hægri) koma með oddmjóum pinna sem auðveldar uppsetningu. Pinninn er með kúlulegu.

Burðarþol á 3mm þykkum hurðalöllum, samstungum og pinna, er **60-80 kg per/3 stk. 80-100 kg per/4 stk.**

Burðarþol á 3,5 – 4,0 mm þykkum hurðalöllum er **80-120 kg per/3stk**



40037-38



40031-32-33-34
(EN 1935:2002 / CE / SUS304)



40018



40019



40020

Vörunn.	Vöruheiti	Stærð	Þykkt	Pinni	Efni	Pakkning
40018	KDH Innihurðal. BS.	89x76 mm	3 mm	7 mm	Burstað stál	50 pör
40019	KDH Innihurðal. ME.	89x76 mm	3 mm	7 mm	Messingh. Stál	50 pör
40020	KDH Innihurðal. RF.	89x76 mm	3 mm	8 mm	Ryðfrítt stál SS304	50 pör
40031*	KDH Eldvarnarlamir	89x76 mm	3 mm	8 mm	Ryðfrítt stál SS304	50 pör
40032*	KDH Eldvarnarlamir	89x89 mm	3 mm	8 mm	Ryðfrítt stál SS304	50 pör
40033*	KDH Eldvarnarlamir	102x76 mm	3 mm	8 mm	Ryðfrítt stál SS304	50 pör
40034*	KDH Eldvarnarlamir	102x89 mm	3 mm	8 mm	Ryðfrítt stál SS304	50 pör
40037	Innih.I. INNIRF.Samst.H	89x89 mm	3 mm	10 mm	Ryðfrítt SS201.hægri	50 pör
40038	Innih.I. INNIRF.Samst.V	89x89 mm	3 mm	10 mm	Ryðfrítt SS201.vinstri	50 pör

*Allar eldvarnarlamir eru með föstum pinna.

KDH Útihurðalamir

Útihurðalamirnar koma í þremur stærðum og koma með legurnar í miðjunni til að auðvelda uppsetningu. Það er sitthvor tegundin af ryðfríu stáli í blaði og pinna til að auka styrk og endingu. KDH 4" x 4" "Messing" lamirnar eru messinghúðað ryðfrítt stál til að ná hámarks styrkleika. KDH 125mm prófil hurðalamir eru með hæðar stillanlegum pinna og fyrir 16mm droprauf.

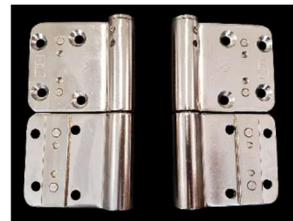

40013-14

Vörunúmer	Vöruheiti	Stærð	Þykkt	Pinni	Efni	Pakkning
40013	KDH Prófil hurðal. H	125 mm	4,0 mm	10 mm	Ryðfrítt stál SS304	10/40 stk
40014	KDH Prófil hurðal. V	125 mm	4,0 mm	10 mm	Ryðfrítt stál SS304	10/40 stk
40021	Útihurðal. RF	102x89 mm	3 mm	8 mm	Ryðfrítt stál SS304	50 pör
40022	Útihurðal. RF	102x102 mm	3 mm	8 mm	Ryðfrítt stál SS304	50 pör
40023	Útihurðal. ME	102x102 mm	3 mm	8 mm	RF stál mess.Húðað	50 pör
40027	Útihurðal. RF	125x102 mm	3,5 mm	8 mm	Ryðfrítt stál SS304	25 pör
40028	Öryggislamir. RF	102x102 mm	3 mm	8 mm	Ryðfrítt stál SS316	37 pör



40022



40023



40027



40028



Kerfislamir fyrir hliðhengd fög

Vörunúmer	Vöruheiti	Stærð fyrir	Efni / Yfirborð	Pakkning
41901	IPA Hliðhengd gluggalöm H	90 mm	Járn / Heitgalv.	10
41902	IPA Hliðhengd gluggalöm V	90 mm	Járn / Heitgalv.	10
41955	IPA Vinkillamir 11457. H	96 mm	Járn / Heitgalv.	10
41956	IPA Vinkillamir 11457. V	96 mm	Járn / Heitgalv.	10

Toppengsli fyrir prófillamir RF



40015 H – 40016 V



41901-2



41955-6



CEMOM

Innfeldar innihurðalamir

ESTETIC ALU 60/A M

- completely invisible hinge for left- and right-handed doors
- load capacity 60 kg/2 hinges
- for use in wooden, steel and especially for aluminum profiles
- for non-rebated doors
- lubrication-free bearing
- 3D adjustment (side +/- 2mm, height +/- 2.5mm, compression +/- 1mm)
- steel front covers (magnetic fixing)
- 180° opening angle



e8060

Satin chrome epoxy



e9005s

Black matte epoxy

classification according to / classificazione in base a / clasificación según /
classification selon la **EN 1935**

2	7	3	0	1	*	0	10
---	---	---	---	---	---	---	----

* corrosion resistance depending on the finish / la resistenza alla corrosione
dipende dalla finitura / resistencia a la corrosión, dependiendo del tipo de
acabado / résistance à la corrosion suivant par la finition

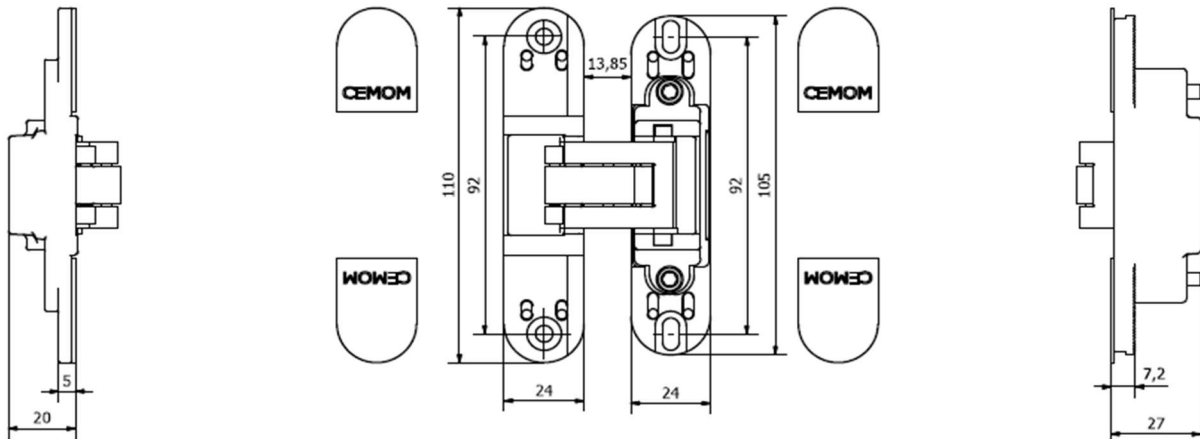

LOAD CAPACITY / CAPACITÀ DI CARICO / CAPACIDAD DE CARGA / RÉSISTANCE

Hinges number Numero cerniere Nombre de bisagras N° charnières	Door width Larghezza porta Ancho de la puerta Largeur porte	700 mm	800 mm	900 mm	1000 mm
2		77 Kg	68 Kg	60 Kg	54 Kg
3		87 Kg	77 Kg	68 Kg	61 Kg
4		96 Kg	85 Kg	75 Kg	68 Kg

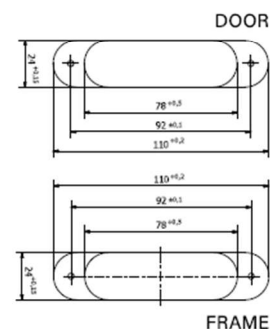
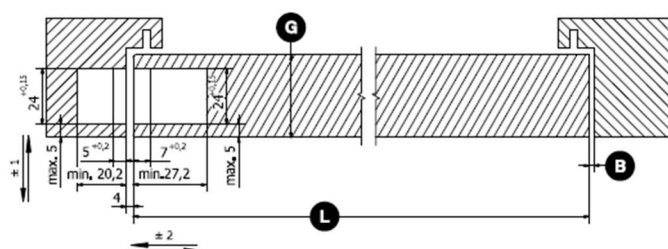

CEMOM

Innfelldar innihurðalamir

ESTETIC 80/A HP M



- completely invisible hinge for left- and right-handed doors
- load capacity 80 kg/2 hinges
- for use in wooden, steel and aluminum profiles
- for non-rebated doors
- lubrication-free bearing
- 3D adjustment (side +/-2mm, height +/- 2mm, compression +/- 1mm)
- steel front covers (magnetic fixing)
- 180° opening angle



e8060

Satin chrome epoxy



e9005s

Black matte epoxy

classification according to / classificazione in base a / clasificación según / classification selon la **EN 1935**

3 | 7 | 4 | 0 | 1 | * | 0 | 11

* corrosion resistance depending on the finish / la resistenza alla corrosione dipende dalla finitura / resistencia a la corrosión, dependiendo del tipo de acabado / résistance à la corrosion suivant par la finition

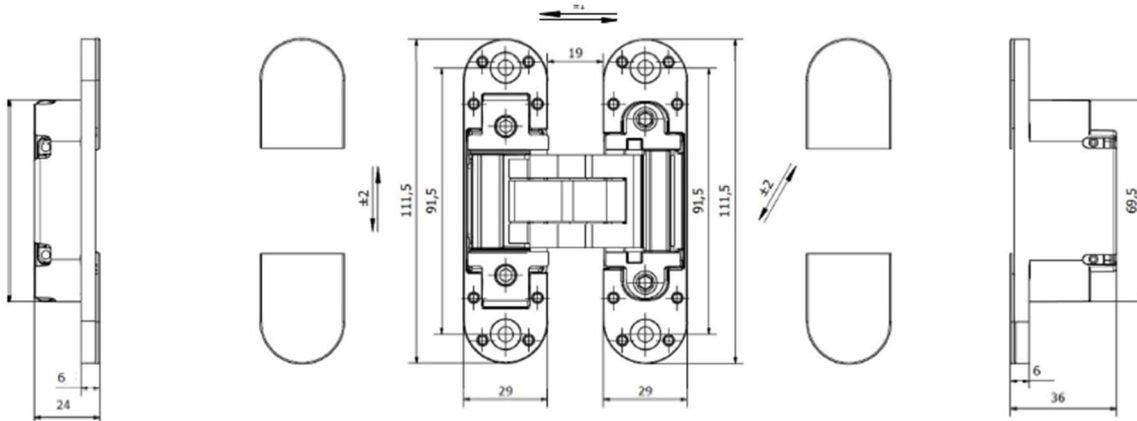

LOAD CAPACITY / CAPACITÀ DI CARICO / CAPACIDAD DE CARGA / RÉSTANCE

Hinges number Numero cerniere Nombre de bisagras N° charnières	Door width Larghezza porta Ancho de la puerta Largeur porte	700 mm	800 mm	900 mm	1000 mm
2		103 Kg	90 Kg	80 Kg	72 Kg
3		115 Kg	100 Kg	90 Kg	81 Kg
4		129 Kg	113 Kg	100 Kg	90 Kg

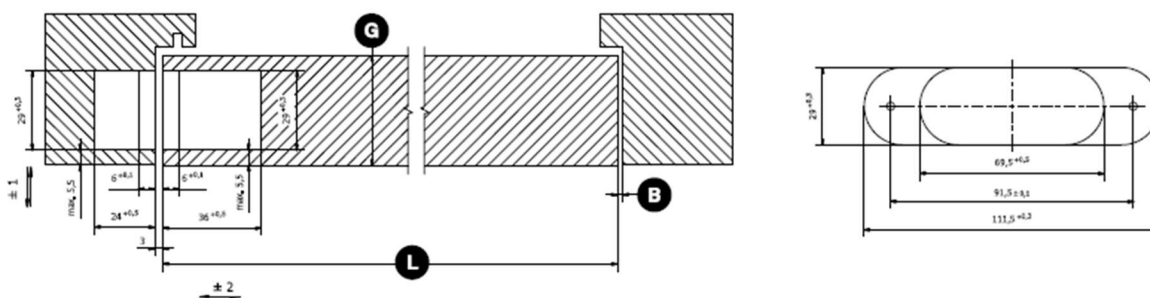

Renson Sonoslot loftunarristar F/ opnanleg fög og karma

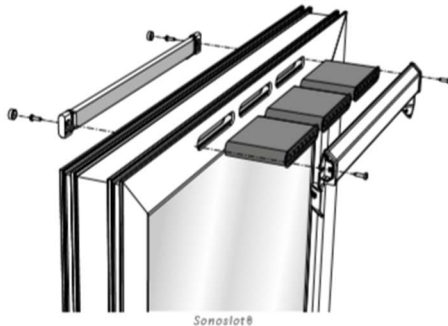

Sonoslot®

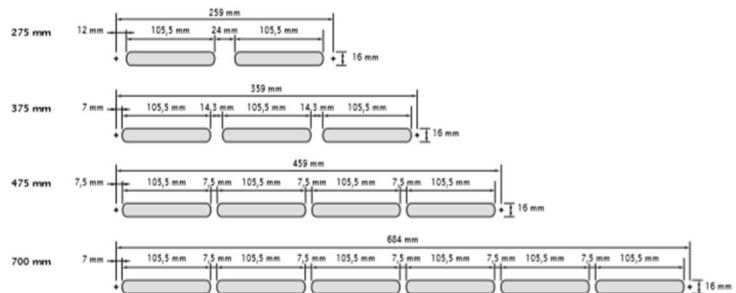

Vörunúmer	Vöruheiti	Litur / Stærð	Pakkning
772182	Renson Sonoslot Hvítt	RAL9010 / 275 mm	1
772184	Renson Sonoslot Brúnt	RAL8016 / 275 mm	1

SCOOP

Ryðfríar Hurðaslár

Vörunúmer	Vöruheiti	Hæð / Festing	Þykkt	Efni
4121200	Inline 1200	1200 mm / 2	mm	RF
4121800	Inline 1800	1800 mm / 3	mm	RF
4122101	Festingar. Gegnumg.			RF
4122105	Festingar. INNI			RF
41180	Festingar F/ In-Flatli.			RF



Q-LON Q-lon þéttlistar, Slottlisti og EPDM Toppf.listi

Vörunúmer	Vöruheiti	Litur	Pakkning
830782-3	Q-lon 3078 þéttlisti	Brúnn/Hvítur	250 m per/rl
830731-2-3	Q-lon 3073 þéttlisti	Grár/Brúnn/Hvítur	200 m per/rl
830043	Q-lon 3004 þéttlisti	Hvítur	350 m per/rl
830053	Q-lon 3005 þéttlisti	Hvítur	300 m per/rl
84125	Þéttlisti slottlisti f/kýlingu	Trans	100 m per/rl
*84835	EPDM 4835 toppf.listi	Svartur	B 3,5-4 x D 4,5. 4,8 frá brún

* EPDM toppfyllingalistinn er settur í nótt glerlista til glerjunar.

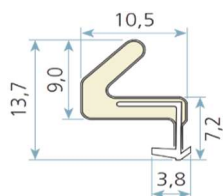

Q-lon 3078

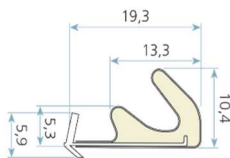

Q-lon 3073

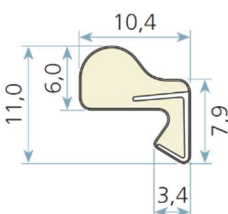

Q-lon 3004

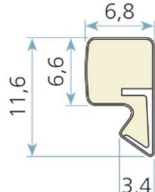

Q-lon 3005

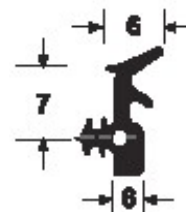

EPDM 4835

Eldvarnar fellipröskuldar og Kerafix 2000 eldglerjunarborðar

Vörunúmer	Vöruheiti	Úrtak í mm	Bil í mm	Db / Eldvörn	Pakkning
640834	Felliprösk.DSD1530 834 mm.	D30 / B15	4-20	50 db / B30	1
640959	Felliprösk.DSD1530 959 mm.	D30 / B15	4-20	50 db / B30	1
641084	Felliprösk.DSD1530 1084 mm	D30 / B15	4-20	50 db / B30	1
641209	Felliprösk.DSD1530 1209 mm	D30 / B15	4-20	50 db / B30	1
82039	Kerafix 2000 Eldvarnargl.listi	Hvítur	3x9 mm	B30	50 m
82069	Kerafix 2000 Eldvarnargl.listi	Hvítur	6x9 mm	B30	50 m

Deventer fellipröskuldar

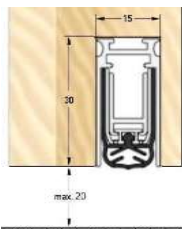

KERAFIX® 2000 Classic /

ROLLTECH

Ál-botnlistar

Rolltech ál botnlistarnir koma í þremur stærðum og þremur litum.

Állistarnir eru eloxeraðir og þar af leiðandi "hvítna" þeir ekki. Hvítu og brúnu állistarnir eru litaðir með púðurhitunar aðferð.

Allir állistarnir koma með gúmmilista.

Klossarnir eru fánlegir fyrir slétt og hallandi (7°) föls.
5 stk klossar per/m og 7-10cm frá enda.

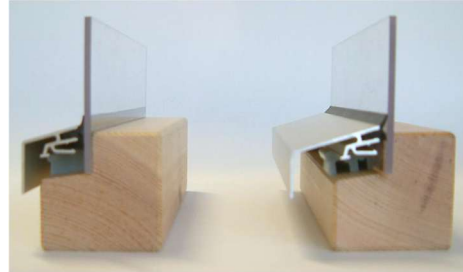

Vörunúmer	Vöruheiti	Litur	Eining
81524	Ál- botnlisti - 24 mm. f/ opnanleg fög	Ál/Eloxeraður	6 m
815241	Ál- botnlisti - 24 mm. f/ opn. fög RAL9010	Hvítur	6 m
815242	Ál- botnlisti - 24 mm. f/ opn. fög RAL8016	Brúnn	6 m
815243	Ál- botnlisti - 24 mm. f/ opn. fög RAL9005	Svartur	6 m
81530	Ál- botnlisti - 30 mm. f/ föst fög	Ál/Eloxeraður	6 m
815301	Ál- botnlisti - 30 mm. f/ föst fög RAL9010	Hvítur	6 m
815302	Ál- botnlisti - 30 mm. f/ föst fög RAL8016	Brúnn	6 m
815303	Ál- botnlisti - 30 mm.f/ föst fög RAL9005	Svartur	6 m
81536	Ál- botnlisti - 36 mm. f/ föst fög	Ál/Eloxeraður	6 m
815361	Ál- botnlisti - 36 mm. f/ föst fög RAL9010	Hvítur	6 m
815362	Ál- botnlisti - 36 mm. f/ föst fög RAL8016	Brúnn	6 m
815363	Ál- botnlisti - 36 mm. f/ föst fög RAL9005	Svartur	6 m
81610	Klossar fyrir slétt föls	Svartur	1 stk.
81611	Klossar fyrir hallandi föls	Svartur	1 stk.

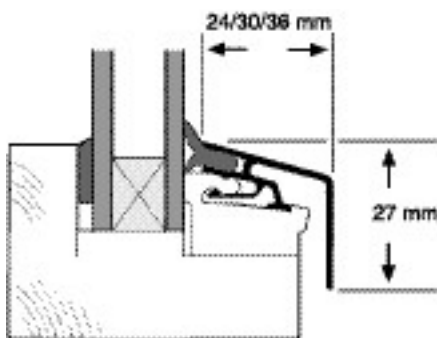



Hurðapumpur

OTS 210

G-U BKS OTS 210 Innihurðapumpurnar fyrir innihurðir.



OTS 430

G-U BKS OTS 430 Inni og útihurðapumpur, Henta vel fyrir **B30 eldvarnarinnihurðir**.



OTS 536

G-U BKS útihurðapumpur eru í hæsta gæðaflokki.

Nr. 2-6 (15-60 Nm). Fyrir flekastærð allt að 1400 mm á breidd. 180° opnun og auðvelt að stilla.



OTS 730

G-U BKS útihurðapumpur eru í hæsta gæðaflokki. Nr. 3-6 (18-60 Nm). Fyrir flekastærð allt að 1400 mm á breidd. 180° opnun og auðvelt að stilla. 730 pumpan er fánleg fyrir braut (sjá mynd).



OTS 210 - 430 - 536



OTS 730 m/ braut

Vörunr.	Vöruheiti	BxH í mm	Litur	Stærð	Hurðastærð breidd í mm	Pakkning
52210	G-U BKS OTS 210 2-4	207 x 58	Silfur	2-4	1100 x 2400	8 stk
52440	G-U BKS OTS 430 2-5	236 x 58	Silfur	2-5	1250 x 2400	6 stk
52442	G-U BKS Armur F/ 430	Braut valkostur fyrir hurðapumpur OTS 210-430				
52444	G-U BKS Braut F/210-430					
52446	G-U BKS Bracket F/ 430	Aukahlutur Fyrir OTS 430				
52536	G-U BKS 536 2-6	296 x 60	Silfur	2-6 15-60 Nm	1400 x 2400	1 stk
52730	G-U BKS OTS 730 3-6	370 x 60	Silfur	3-6 18-60 Nm	1400 x 2400	1 stk
422026	KDH Hurðastoppari	32 x 26 mm	RF			10 stk



KDH Hurðastoppari RF.
Fyrir gólf og vegg. 32x26 mm



422026

SCOOP Innihurðahúnarnir með Slidebloc gormakerfi sem heldur þeim uppi.



1084



1106



1104

Vörunr.	Vöruheiti	Lengd	Hæð	Pinni	Þykkt	Efni / gat	Pakkning
431084	Scoop RF hurðah.1084	132 mm	60 mm	8 mm	20 mm	RF / 38 mm	1 stk
431104	Scoop RF hurðah.1104	135 mm	58 mm	8 mm	20 mm	RF / 38 mm	1 stk
431106	Scoop RF hurðah.1106	135 mm	58 mm	8 mm	20 mm	RF / 38 mm	1 stk
431200	Scoop útihurðah.f/ 55/92	135 mm	58 mm	8 mm	20 mm	RF	1 stk
42190	RF lykillauf f/lykla	54 mm			10 mm	RF	1 stk
42192	RF lykillauf f/síllindra	54 mm			10 mm	RF	1 stk
431111	Scoop RF WC læsing	54 mm		8 mm	10 mm	RF / 38 mm	1 stk



431200

Þýsk gæði á frábæru verði

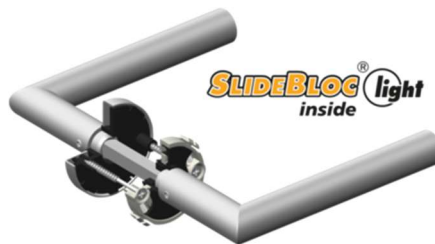

431111



42190

42192

G-U BKS Útihurðahúnar

Vörunr.	Vöruheiti	Breidd	Hæð	Þykkt	Efni / gat	Pakkning
622871	G-U Handfang Neptune	24 mm	234 mm	10 mm	Matt króm	1 stk
622872	G-U Handfang Neptune	40 mm	234 mm	10 mm	Matt króm	1 stk
622873	G-U Handf. Neptune.m/hnúð	40 mm	234 mm	10 mm	Matt króm	1 stk
622880	FabnFix Balmoral Graphite	32 mm	243 mm	10 mm	Graphite	1 stk

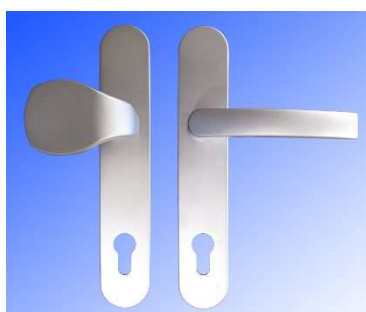

Neptune



Balmoral

KDH Skápahöldur Úr gegnheilu ryðfríu stáli

Skápahöldur Nr.005

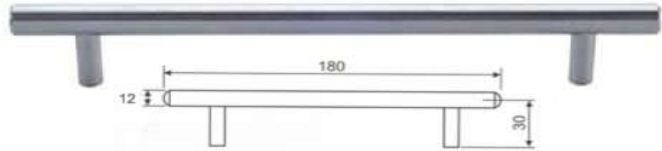

Ryðfríar 12 mm höldur til í stærðum (Lengd milli gata)
128 mm, 160 mm, 192 mm, 256 mm, 320 mm,
400 mm, 500 mm, 600 mm, 700 mm, 800 mm,
900 mm, 1000 mm, 1200 mm, 1400 mm, 1600 mm.
Heildarlengd höldu er lengd.m.gata + 50 mm

Skápahöldur Nr.006

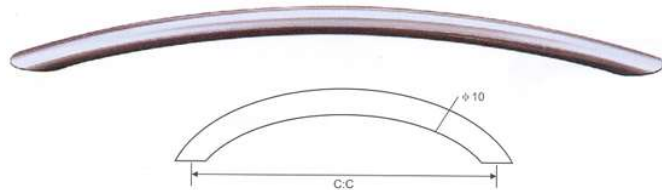

Ryðfríar 10 mm höldur til í stærðum
96 mm, 128 mm, 192 mm, 320 mm.

Skápahöldur NR.007

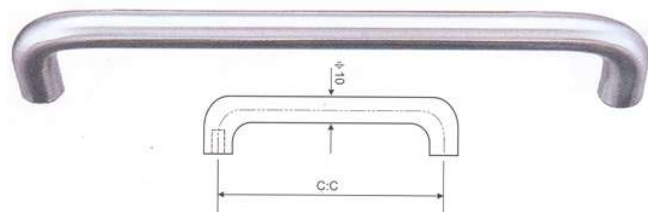

Ryðfríar 10 mm höldur til í stærðum
96 mm, 128 mm, 192 mm, 256 mm, 320 mm,



449039



449042



448064

Vörunúmer	Vöruheiti	Hæð	Þykkt	Efni	Pakkning
449039	KDH hnúðar RF	28 mm	25 mm	Ryðfrítt stál	20
449042	KDH hnúðar RF	29 mm	25 mm	Ryðfrítt stál	20
448064	Skápahöldur Nr.008	64 mm	10 mm	Ryðfrítt	50 / 200

GU BKS G-U 934 Rennihurða fittings

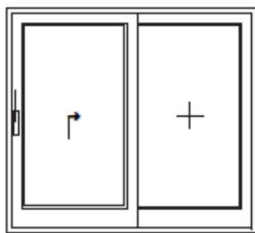

Einföld

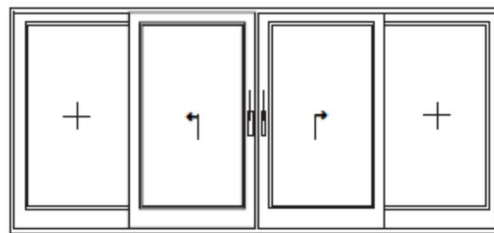

Tvöföld

Vörunúmer	Vöruheiti	lengd
6709547	GU - Botnbraut 934 f/ RH - Ál	4 m
6710566	GU - Toppskúffa 45 mm / K-10894 - Ál	4 m
6716488	GU - Hjól f/ RH 934/954	
6716606	GU - Lásbolta fittings f/ RH 934/954	
6724606	GU - Handfang Ál f/ RH EV1	
6725476	GU - Tengijárn f/ RH læsingu 30021	1,86 m
6729526	GU - Halda innfelld Ál f/ RH 934/954	
6730021	GU - Læsing f/ RH 934/954 - 37,5 mm	2,28 m
6735996	GU - Þéttiklossi - Gúmmí f/ RH	
6811051	GU - Púðar f/ RH 934/954	
6775101	GU - Þéttilisti f/ RH P-743	
6875103	GU - Þéttilisti f/ RH P-1156	
6875743	GU - Þéttilisti f/ RH P-742	



G-U 934 Rennihurða fittings / aukahlutir

Vörunúmer	Vöruheiti	lengd
6713267	GU - Handfang tvöfalt úti-inni Ál / RH. EV1	
6716793	GU - Handfang Ryðfrítt m/ höldu f/ RH	
6816607	GU - Lásbolta fittings f/ tvöföldun f/ RH 934	
6815797	GU - Samlokulisti f/ RH 934/954 10 mm	2,4 m
6815798	GU - Samlokulisti f/ RH 934/954 16 mm	2,4 m

Type of element	GU-934 door
Sash weight in kg	up to 300*
Sash width, mm	700 - 3300
Sash height, mm	1851 - 3250**



Einnotahanskar úr nitril frá Imtex. Sterkir þægilegir



Senzi



X-Soft

Vörunr.	Vöruheiti / Stærðir	Lengd	Þykkt	Efni / litur	Pakkning
90013-14-15	Einnotah. Sensi / S-M-L-XL	240 mm	0,06 mm	Nitril / Hvítir	100 stk / 10 ks
90010-11-12	Einnotah. X-Soft / M-L-XL	240 mm	0,10 mm	Nitril / Bláir	100 stk / 10 ks



Vörunr.	Vöruheiti / Stærðir	Stærð	Efni	Pakkning
90002	Sitrix V1 Þurrkur	34 x 30 cm	55% cellulose 45%polyester	50 stk / 12 ks
90001	Sitrix V3 Þurrku Rúlla	34 x 38 cm		500 bl / 1 rl



Loftbyssur fyrir galv og RF pinna og hefti, polymer plast pinna og hefti.

(Þarf ekki að plokka úr fyrir fræsiténnur eða sagarblöð)



12.20 p (polymer)



17.55 p (polymer)



81 p (polymer)



MG 40 (pinnar RF/Galv)



90.40 (hefti 90)

Vörunr.	Vöruheiti	Pinna / hefti mm	Magn í kassa	Pakkning
321200	Omer loftpinnabyssa 12.20 p	12 - 20 mm		1 stk
321216	Omer polymer pinnar f/ 12.20 p	16 mm	2000	1 pk
321220	Omer polymer pinnar f/ 12.20 p	20 mm	2000	1 pk
321700	Omer loftpinnabyssa 17.55 p	20 - 55 mm		1stk
321725	Omer polymer pinnar f/ 17.55 p	25 mm	2350	1 pk
321732	Omer polymer pinnar f/ 17.55 p	32 mm	2350	1 pk
328100	Omer loftheftibyssa 81 p	6 - 14 mm		1 stk
328110	Omer polymer hefti f/ 81 p	10 mm	5040	1 pk
328114	Omer polymer hefti f/ 81 p	14 mm	5040	1 pk
328540	Omer loftpinnab. MG 40. RF/Galv.	12 - 40mm		1 stk
328430	Omer pinnar - hauslaus 30 mm - Galv.	30 mm (MG40)	14000	1 pk
328530	Omer pinnar - m/ haus 30mm - RF. i304	30 mm (MG40)	12500	1 pk
329040	Omer loftheftibyssa Nr. 90 RF/Galv.	20 - 40mm		1 stk
329090	Omer hefti Nr.90. RF. i304	32 mm	5000	1 pk